

Part number

CAV 24 LG29



Brief description:

Hoods with single lever, size "104.27", top entry, Pg29, metal version, IP66

Product description

Version	metal version
Series	Hoods with single lever
Product type	with 1 lever
Variant	top entry
Style	high construction
Family	CLASS enclosures
Size	size "104.27"

Technical data

Material	metal
IP degree of protection	IP66 (and IP69K DIN 40050 - 9)
Cable entry	Pg29

Further technical details

Weight	350,00 g
---------------	----------

Approvals / Standards

Quality mark	 (type:4/4X/12),  , EAC
Conformity	CQC, CE

General ordering information

EAN13 code	8015747010030
Tariff number	85369095

Packaging Information

Packaging length	250,00 mm
Packaging height	145,00 mm
Packaging width	300,00 mm
Packaging weight	3,50 kg
Packaging volume	10,88 dm ³
Packaging description	Carton box
Packaging quantity	10 Pcs
Packaging EAN code	8015747226196
Sub-packaging weight	1,75 kg
Sub-packaging description	Plastic packaging
Sub-packaging quantity	5 Pcs
Sub-packaging EAN barcode	8015747010047

Part number

CAV 24 LG29



Catalogue drawings

**CHO L (CAO L) - MHO L [MAO L]
CHV L [CAV L] - MHV L (MAV L)**

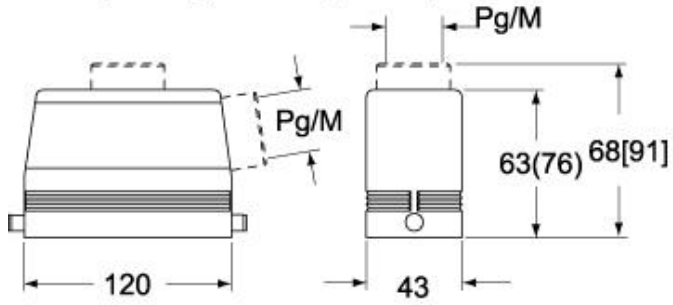

CHV LG (CAV LG), MHV LG (MAV LG) [MFV LG]

